

LUNAROSSA Vanity Item # Z501A

Features:

- Free-standing under-counter vanity
- Two doors (pulls included) and one adjustable shelf
- Main vanity body constructed of veneered high-grade plywood
- Counter top Z501T and sink 5452UN are sold separately
- Handmade in USA
- Manufactured with low VOC finishes and wood from renewable forests

Recommended Accesories:

- Item #Z501T Countertop, available in stone or quartz and solid surface.
- Item #5452UN: Porcelain washbasin with overflow
- Under-counter installation
- Oversized European drain Recommended (i.e. item #7100-16OF or 7100-12)
- Available in: White (-001) only



Product Specifications:

Finish Options:

- 02 - Natural Cherry
- 06 - Wedge
- 07 - Natural Walnut
- 08 - Matte White (TEX1 - fine texture)
- 16 - Matte Black (TEX1 - fine texture)
- 18 - Ebony
- 20 - Ash Gray
- 22 - Gray Zebra
- 24 - Classic Walnut
- 31 - White Oak
- 33 - African Mahogany
- 34 - Matte Mocha (TEX1 - fine texture)
- 35 - Matte Ardesia (TEX1 - fine texture)
- 36 - Espresso
- 37 - Weathered Oak
- 52 - Silver Oak
- 85 - Gloss White
- 86 - Gloss Black
- 87 - Gloss Mocha
- 88 - Gloss Ardesia

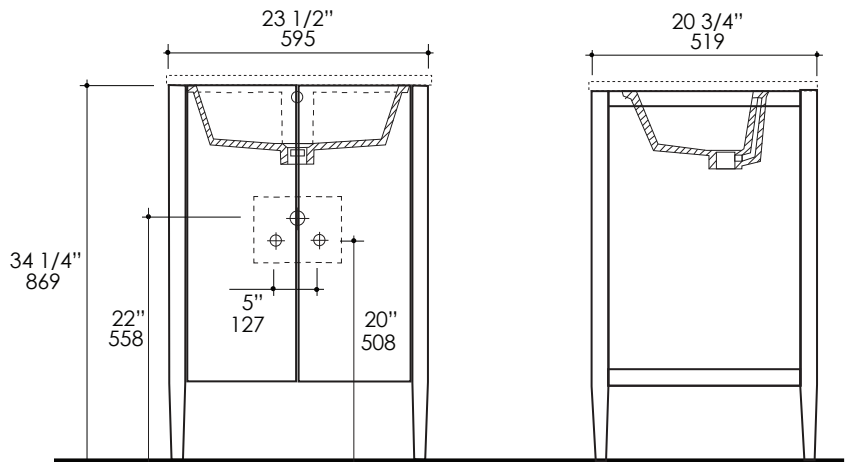

Notes:
 Drawings provided herein are meant to give the user an idea of the product and are not made to scale. The size in inches is rounded up to the nearest 1/16". Slight variances can often occur with porcelain and woodwork. Therefore, LACAVA will not be held responsible for any cutouts, countertops, or furniture made without the actual product or template from LACAVA. Differences in color, grain, appearance and texture are inherent in all natural woodwork, and should be expected. Variances in these qualities are not deemed manufacturing defects, and will not be accepted as valid reasons to return or exchange any LACAVA woodwork. Plumbing specifications are only a guideline and may need to be altered based on the application. Product specifications are not binding to the manufacturer and can be changed without notice at any time. Please refer to your shipment for product final sizes.

LACAVA is committed to the highest level of customer service. Please feel free to contact us at 1-888-522-2823 (toll free) or by email at info@lacava.com for technical assistance or any general inquiries.

Rev. 12-27-2017